

DETAIL OF MOUNTING BLOCK

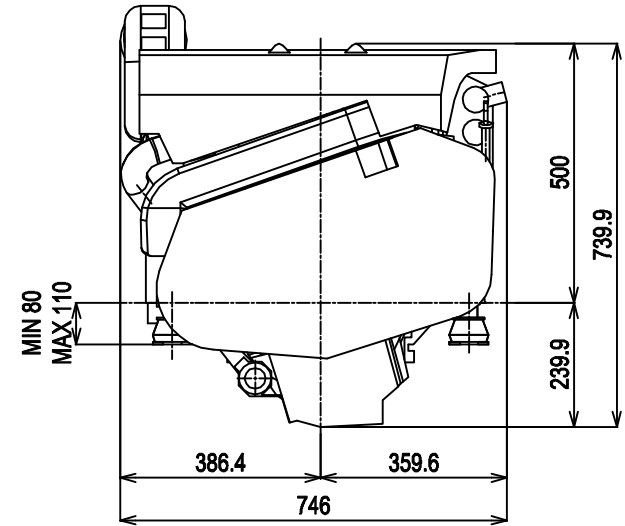

DETAIL OF COUPLING

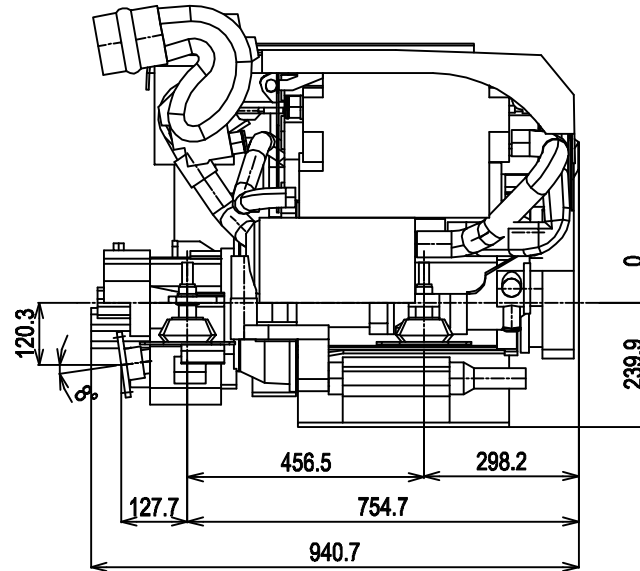
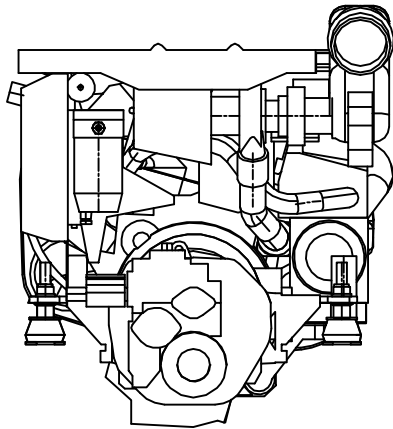
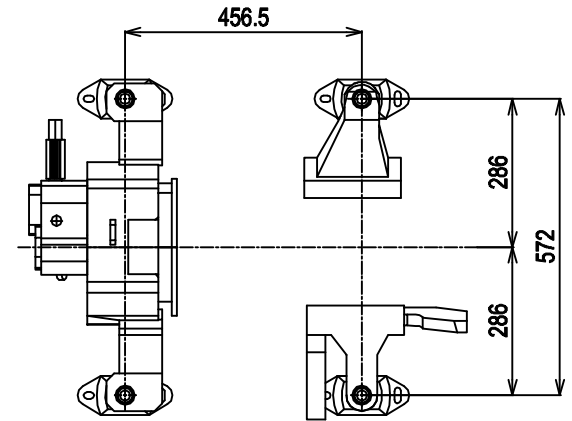
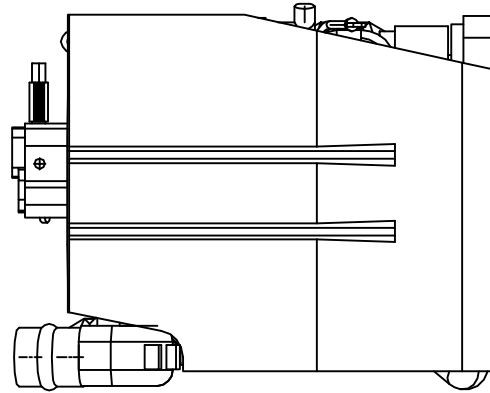
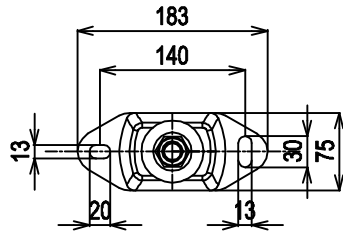
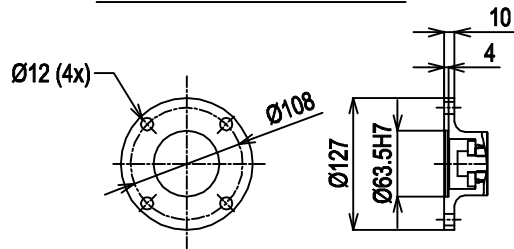

NOTE: ALL DIMENSIONS ARE IN MM

Scale
1/10

YANMAR MARINE INTERNATIONAL
November 2006

4BY150-180xKMH40A